

# Entry Doors

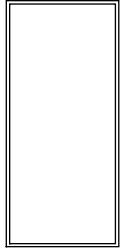

## Panel Styles

SP6-2



FLUSH

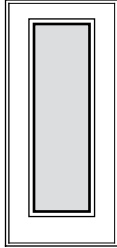

FULL LITE

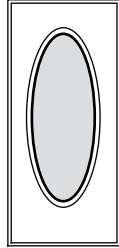

OVAL

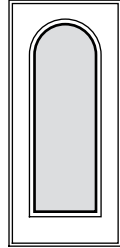

FULL  
SPRINGLINE

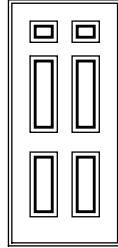

6-PANEL

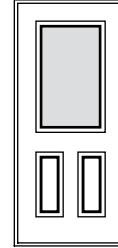

HALF LITE

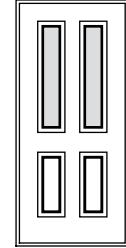

TWIN  
HALF LITE

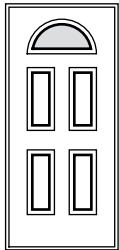

4-PANEL  
CIRCLEHEAD

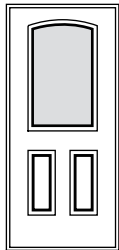

HALF  
ARCH HEAD

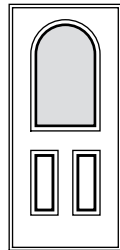

HALF  
SPRINGLINE

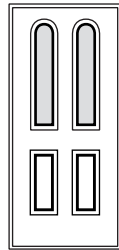

TWIN HALF  
SPRINGLINE

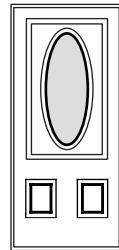

3-PANEL  
OVAL

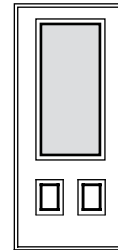

3/4 LITE

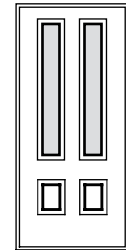

TWIN 3/4 LITE

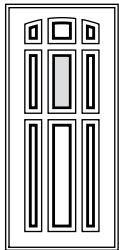

9-PANEL  
CENTER LITE

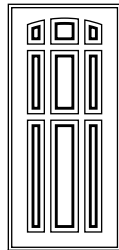

9-PANEL

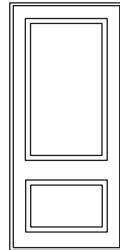

EUROPEAN  
2-PANEL

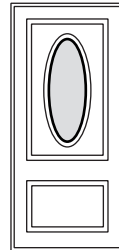

EUROPEAN  
2-PANEL OVAL

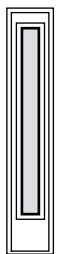

FULL LITE



HALF LITE



3/4 LITE



HALF  
SPRINGLINE

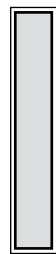

DIRECT SET  
GLASS

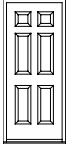

# Entry Doors



## Design Data

SP6-4

### Clad Doors

	Door Size	Clear Opening Dim. @ 180			Clear Opening Dim. @ 90		
		Width	Height	Total Sq. Ft.	Width	Height	Total Sq. Ft.
Inswing	28" x 68"	30-7/8"	78-7/8"	16.9	29-1/8"	78-7/8"	16.0
	28" x 70"	30-7/8"	82-7/8"	17.8	29-1/8"	82-7/8"	16.8
	28" x 80"	30-7/8"	94-7/8"	20.3	29-1/8"	94-7/8"	19.2
	30" x 68"	34-7/8"	78-7/8"	19.1	33-1/8"	78-7/8"	18.2
	30" x 68" ADA	34-7/8"	78-7/8"	19.1	33-1/8"	78-7/8"	18.2
	30" x 70"	34-7/8"	82-7/8"	20.1	33-1/8"	82-7/8"	19.1
	30" x 70" ADA	34-7/8"	82-7/8"	20.1	33-1/8"	82-7/8"	19.1
	30" x 80"	34-7/8"	94-7/8"	23.0	33-1/8"	94-7/8"	21.8
	30" x 80" ADA	34-7/8"	94-7/8"	23.0	33-1/8"	94-7/8"	21.8

### Wood Doors

	Door Size	Clear Opening Dim. @ 180			Clear Opening Dim. @ 90		
		Width	Height	Total Sq. Ft.	Width	Height	Total Sq. Ft.
Inswing	28" x 68"	31-1/16"	79-1/16"	17.0	29-1/4"	79"	16.0
	28" x 70"	31-1/16"	83-1/16"	17.9	29-1/4"	83"	16.9
	28" x 80"	31-1/16"	95-1/16"	20.5	29-1/4"	95"	19.3
	30" x 68"	35-1/16"	79-1/16"	19.2	33-1/4"	79"	18.2
	30" x 68" ADA	35-1/16"	79-1/16"	19.3	33-1/4"	79-1/16"	18.2
	30" x 70"	35-1/16"	83-1/16"	20.2	33-1/4"	83"	19.2
	30" x 70" ADA	35-1/16"	83-1/16"	20.2	33-1/4"	83-1/16"	19.2
	30" x 80"	35-1/16"	95-1/16"	23.1	33-1/4"	95"	21.9
	30" x 80" ADA	35-1/16"	95-1/16"	23.2	33-1/4"	95-1/16"	21.9
Out-Swing	28" x 68"	31-1/16"	78-1/16"	16.8	29-1/4"	78-1/16"	15.8
	28" x 70"	31-1/16"	82-1/16"	17.7	29-1/4"	82-1/16"	16.7
	28" x 80"	31-1/16"	94-1/16"	20.3	29-1/4"	94-1/16"	19.1
	30" x 68"	35-1/16"	78-1/16"	19.0	33-1/4"	78-1/16"	18.0
	30" x 70"	35-1/16"	82-1/16"	20.0	33-1/4"	82-1/16"	18.9
	30" x 80"	35-1/16"	94-1/16"	22.9	33-1/4"	94-1/16"	21.7

All dimensions are approximate to the nearest 1/16"  
 To convert areas to square meters (m<sup>2</sup>), multiply square feet by 0.0929

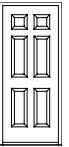

## Decorative Glass Collections

SP6-5



### Athena Collection™

- An elegant contemporary design combining private, colorless textured glass with exclusive nickel-plated came
- Features custom-created, hand-cut obscure and polished clear bevels
- Includes Reedlite and Frosted Satin glass



### Isabella Collection™

- A contemporary geometric design featuring privacy-oriented colorless textured and pearl art glass, straight lines of solid roll-formed brass came
- Features custom-created, hand-cut and -polished, multifaceted bevels
- Includes Granite, Frosted Delta and Glue Chip glass with Wissmach pearl white glass accents



### Francesca Collection™

- A dazzling beveled glass centerpiece and border, surrounded with obscure, colorless textured art glass, assembled in solid roll-formed brass came
- Features 35mm 24% lead crystal jewels
- Includes Ripple and Glue Chip glass



### Juliet Collection™

- A stunning combination of sparkling yet private, colorless textured art glass, wrapped with black patina zinc coming.
- Features 35mm and 25mm 24% lead crystal jewels
- Includes Frosted Delta, Ripple, Chord and Baroque™ glass



### Guinevere Collection™

- Lovely beveled glass clusters with border, obscure colorless textured art glass, assembled with solid roll-formed brass came
- Features 50mm and 35mm 24% lead crystal jewels
- Includes Glue Chip and Sparkle glass



### Victoria Collection™

- A delightful beveled-glass feature piece with pencil-beveled border highlights, a fabulous soft swirling gray Baroque™ glass background and colorless Ripple glass border, assembled with solid roll-formed brass came
- Features highlights of hand-polished, multifaceted diamond bevels
- Includes Ripple and gray Baroque glass

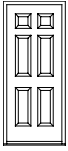

# Entry Doors



## Carbonite™ Panel Style, Size and Glazing Options

SP6-6

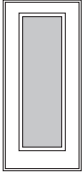
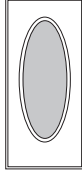
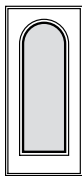
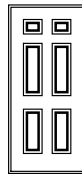
Panel Style	Door Size	Reference Glass Size	Glass Type								Muntins		
			Juliet	Francesca	Victoria	Guinevere	Athena	Isabella	Clear	Low-E	Grilles-Between-The-Glass		
Flush 	2'8 x 6'8 3'0 x 6'8	NA NA											
Full Lite 	2'8 x 6'8 3'0 x 6'8 2'8 x 8'0 3'0 x 8'0	22 x 64 22 x 64 22 x 80 22 x 80		●	●	●	●	●	●	●	●	●	●
Oval 	2'8 x 6'8 3'0 x 6'8	20 x 56 20 x 56		●	●						●		
Full Springline 	2'8 x 6'8 3'0 x 6'8	22 x 64 22 x 64	●	●		●					●		
6-Panel 	2'8 x 6'8 3'0 x 6'8 2'8 x 8'0 3'0 x 8'0	NA NA NA NA											



# Entry Doors



## Carbonite™ Panel Style, Size and Glazing Options

SP6-7

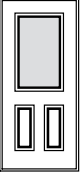
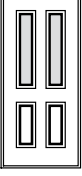
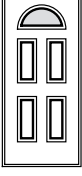
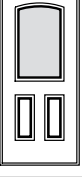
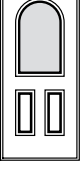
Panel Style	Door Size	Reference Glass Size	Glass Type									Muntins		
			Juliet	Francesca	Victoria	Guinevere	Athena	Isabella	Clear	Low-E	Grilles-	Between-	The-Glass	
Half Lite 	2'8 x 6'8	22 x 36		●	●		●	●	●	●	●	●	●	
	3'0 x 6'8	22 x 36		●	●		●	●	●	●	●	●	●	
	2'8 x 8'0	22 x 48	●	●	●	●	●	●	●	●	●	●	●	
	3'0 x 8'0	22 x 48	●	●	●	●	●	●	●	●	●	●	●	
Twin Half Lite 	2'8 x 6'8	8 x 36			●				●		●			
	3'0 x 6'8	8 x 36			●				●		●			
4-Panel (CH) 	2'8 x 6'8	22 x 10			●	●			●		●	●		
	3'0 x 6'8	22 x 10			●	●			●		●	●		
Half Lite Arch Head 	2'8 x 6'8	22 x 38	●			●					●			
	3'0 x 6'8	22 x 38	●			●					●			
Half Lite Springline 	2'8 x 6'8	22 x 36	●			●					●			
	3'0 x 6'8	22 x 36	●			●					●			

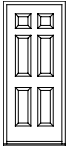

# Entry Doors



## Carbonite™ Panel Style, Size and Glazing Options

SP6-8

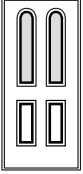
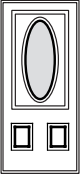
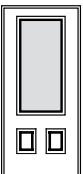
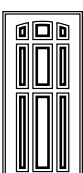
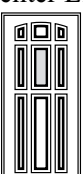
Panel Style	Door Size	Reference Glass Size	Glass Type								Muntins	
			Juliet	Francesca	Victoria	Guinevere	Athena	Isabella	Clear	Low-E	Grilles- Between- The-Glass	
Twin Half Springline 	2'8 x 6'8 3'0 x 6'8	8 x 36 8 x 36			● ●	● ●					● ●	
3-Panel Oval 	2'8 x 6'8 3'0 x 6'8	14 x 37 14 x 37		● ●	● ●				● ●		● ●	
3/4 Lite 	2'8 x 6'8 3'0 x 6'8	22 x 48 22 x 48	● ●	● ●	● ●	● ●	● ●	● ●			● ●	● ●
9-Panel 	2'8 x 6'8 3'0 x 6'8	NA NA										
9-Panel Center Lite 	2'8 x 6'8 3'0 x 6'8	7.5 x 18.5 7.5 x 18.5			● ●			● ●	● ●		● ●	



# Entry Doors

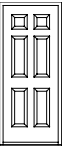

## Carbonite™ Panel Style, Size and Glazing Options

SP6-9

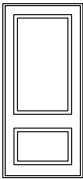
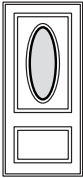
Panel Style	Door Size	Reference Glass Size	Glass Type								
			Juliet	Francesca	Victoria	Guinevere	Athena	Isabella	Clear	Low-E	
European 2-Panel* 	2'8 x 6'8 3'0 x 6'8	NA NA									
European 2-Panel Oval* 	2'8 x 6'8 3'0 x 6'8	12 x 34 12 x 34		● ●	● ●				● ●		● ●

\* Walnut Grain

### Sidelights

Shape	Door Size	Reference Glass Size	Glass Type								Muntins	
			Juliet	Francesca	Victoria	Guinevere	Athena	Isabella	Clear	Low-E	Grilles- Between- The-Glass	
Full Lite Sidelight 	1'0 x 6'6	7 x 64	●	●	●	●	●	●	●	●	●	●
	1'2 x 6'6	7 x 64	●	●	●	●	●	●	●	●	●	●
	1'0 x 6'8	7 x 64	●	●	●	●	●	●	●	●	●	●
	1'2 x 6'8	7 x 64	●	●	●	●	●	●	●	●	●	●

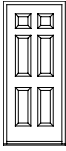





# Entry Doors



## Carbonite™ Panel Style, Size and Glazing Options

SP6-10

### Sidelights

Shape	Door Size	Reference Glass Size	Door Type								Muntins	
			Juliet	Francesca	Victoria	Guinevere	Athena	Isabella	Clear	Low-E	Grilles-Between-The-Glass	
Full Lite Sidelight* 	1'0 x 6'8	7 x 64	●	●	●	●	●	●	●	●	●	
	1'2 x 6'8	7 x 64	●	●	●	●	●	●	●	●	●	
3/4 Lite Sidelight 	1'0 x 6'8	8 x 48	●	●	●	●	●	●		●	●	
	1'2 x 6'8	8 x 48	●	●	●	●	●	●		●	●	
Half Lite Sidelight 	1'0 x 6'8	8 x 36	●	●	●	●	●	●	●	●	●	
	1'2 x 6'8	8 x 36	●	●	●	●	●	●	●	●	●	
	1'0 x 8'0	8 x 48	●	●	●	●	●	●	●	●	●	
	1'2 x 8'0	8 x 48	●	●	●	●	●	●	●	●	●	
Half Springline Sidelight 	1'0 x 6'8	8 x 36			●	●				●		
	1'2 x 6'8	8 x 36			●	●				●		

\* Walnut Grain

### Direct Set Sidelight

	1'0 x 6'8								●	●	●
	1'2 x 6'8								●	●	●
	1'0 x 7'0								●	●	●
	1'2 x 7'0								●	●	●
	1'0 x 8'0								●	●	●
	1'2 x 8'0								●	●	●



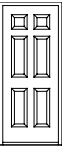

# Entry Doors



## Steel Panel Style, Size and Glazing Options

SP6-11

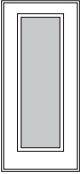
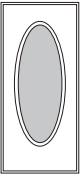
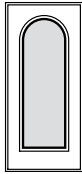
Shape	Door Size	Reference Glass Size	Glass Type								Muntins	
			Juliet	Francesca	Victoria	Guinevere	Athena	Isabella	Clear	Low-E	Grilles-Between-Glass	The-Glass
Flush 	2'8 x 6'8	NA										
	3'0 x 6'8	NA										
	2'8 x 7'0	NA										
	3'0 x 7'0	NA										
	2'8 x 8'0	NA										
	3'0 x 8'0	NA										
Flush Utility 	2'8 x 6'8	NA										
	3'0 x 6'8	NA										
Full Lite 	2'8 x 6'8	22 x 64		●	●	●	●	●	●	●	●	●
	3'0 x 6'8	22 x 64		●	●	●	●	●	●	●	●	●
	2'8 x 7'0	22 x 64		●	●	●	●	●	●	●	●	●
	3'0 x 7'0	22 x 64		●	●	●	●	●	●	●	●	●
	2'8 x 8'0	22 x 80	●	●	●	●	●	●	●	●	●	●
	3'0 x 8'0	22 x 80	●	●	●	●	●	●	●	●	●	●
Oval 	2'8 x 6'8	20 x 56		●	●					●		
	3'0 x 6'8	20 x 56		●	●					●		
	2'8 x 7'0	20 x 56		●	●					●		
	3'0 x 7'0	20 x 56		●	●					●		
Full Springline 	2'8 x 6'8	22 x 64	●	●		●				●		
	3'0 x 6'8	22 x 64	●	●		●				●		
	2'8 x 7'0	22 x 64	●	●		●				●		
	3'0 x 7'0	22 x 64	●	●		●				●		

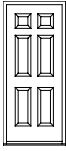

# Entry Doors



## Steel Panel Style, Size and Glazing Options

SP6-12

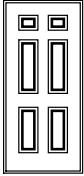
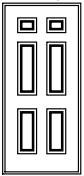
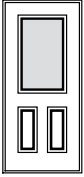
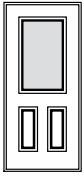
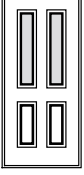
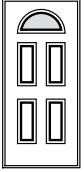
Shape	Door Size	Reference Glass Size	Glass Type									Muntins	
			Juliet	Francesca	Victoria	Guinevere	Athena	Isabella	Clear	Low-E	Grilles-Between-The-Glass		
6-Panel 	2'8 x 6'8	NA											
	3'0 x 6'8	NA											
	2'8 x 7'0	NA											
	3'0 x 7'0	NA											
6-Panel Utility 	2'8 x 6'8	NA											
	3'0 x 6'8	NA											
Half Lite 	2'8 x 6'8	22 x 36		●	●		●	●	●	●	●		
	3'0 x 6'8	22 x 36		●	●		●	●	●	●	●		
	2'8 x 7'0	22 x 36		●	●		●	●	●	●	●		
	3'0 x 7'0	22 x 36		●	●		●	●	●	●	●		
Half Lite Utility 	2'8 x 6'8	22 x 36							●		●		
	3'0 x 6'8	22 x 36							●		●		
Twin Half Lite 	2'8 x 6'8	8 x 36			●			●	●	●			
	3'0 x 6'8	8 x 36			●			●	●	●			
	2'8 x 7'0	8 x 36			●			●	●	●			
	3'0 x 7'0	8 x 36			●			●	●	●			
4-Panel (CH) 	2'8 x 6'8	22 x 10			●	●		●	●	●	●		
	3'0 x 6'8	22 x 10			●	●		●	●	●	●		
	2'8 x 7'0	22 x 10			●	●		●	●	●	●		
	3'0 x 7'0	22 x 10			●	●		●	●	●	●		



# Entry Doors

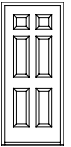

## Steel Panel Style, Size and Glazing Options

SP6-13

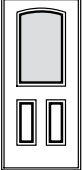
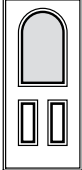
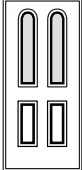
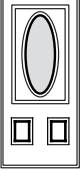
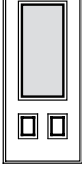
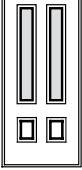
Shape	Door Size	Reference Glass Size	Glass Type								Muntins
			Juliet	Francesca	Victoria	Guinevere	Athena	Isabella	Clear	Low-E	Grilles-Between-The-Glass
Half Lite Arch Head 	2'8 x 6'8	22 x 38	●			●				●	
	3'0 x 6'8	22 x 38	●			●				●	
	2'8 x 7'0	22 x 38	●			●				●	
	3'0 x 7'0	22 x 38	●			●				●	
Half Lite Springline 	2'8 x 6'8	22 x 36	●			●				●	
	3'0 x 6'8	22 x 36	●			●				●	
	2'8 x 7'0	22 x 36	●			●				●	
	3'0 x 7'0	22 x 36	●			●				●	
Twin Half Springline 	2'8 x 6'8	8 x 36			●	●				●	
	3'0 x 6'8	8 x 36			●	●				●	
	2'8 x 7'0	8 x 36			●	●				●	
	3'0 x 7'0	8 x 36			●	●				●	
3-Panel Oval 	2'8 x 6'8	14 x 37		●	●			●		●	
	3'0 x 6'8	14 x 37		●	●			●		●	
3/4 Lite 	2'8 x 6'8	22 x 48	●	●	●	●	●	●		●	●
	3'0 x 6'8	22 x 48	●	●	●	●	●	●		●	●
	2'8 x 7'0	22 x 48	●	●	●	●	●	●		●	●
	3'0 x 7'0	22 x 48	●	●	●	●	●	●		●	●
Twin 3/4 Lite 	2'8 x 6'8	8 x 48			●			●		●	
	3'0 x 6'8	8 x 48			●			●		●	
	2'8 x 7'0	8 x 48			●			●		●	
	3'0 x 7'0	8 x 48			●			●		●	

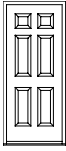

# Entry Doors



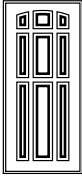
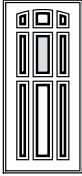

## Steel Panel Style, Size and Glazing Options

SP6-14

Shape	Door Size	Reference Glass Size	Glass Type									Muntins		
			Juliet	Francesca	Victoria	Guinevere	Athena	Isabella	Clear	Low-E	Grilles-Between-The-Glass			
9-Panel 	2'8 x 6'8 3'0 x 6'8	NA NA												
9-Panel Center Lite 	2'8 x 6'8 3'0 x 6'8	7.5 x 18.5 7.5 x 18.5			● ●			● ●	● ●			● ●		

### Sidelights

Shape	Door Size	Reference Glass Size	Glass Type									Muntins		
			Juliet	Francesca	Victoria	Guinevere	Athena	Isabella	Clear	Low-E	Grilles-Between-The-Glass			
Full Lite Sidelight 	1'0 x 6'8 1'2 x 6'8 1'0 x 7'0 1'2 x 7'0 1'0 x 8'0 1'2 x 8'0	7 x 64 7 x 64 7 x 64 7 x 64 8 x 80 8 x 80	● ● ● ● ● ●	● ● ● ● ● ●	● ● ● ● ● ●	● ● ● ● ● ●	● ● ● ● ● ●	● ● ● ● ● ●	● ● ● ● ● ●	● ● ● ● ● ●	● ● ● ● ● ●	● ● ● ● ● ●	● ● ● ● ● ●	● ● ● ● ● ●
3/4 Lite Sidelight 	1'0 x 6'8 1'2 x 6'8 1'0 x 7'0 1'2 x 7'0	8 x 48 8 x 48 8 x 48 8 x 48	● ● ● ●	● ● ● ●	● ● ● ●	● ● ● ●	● ● ● ●	● ● ● ●	● ● ● ●	● ● ● ●	● ● ● ●	● ● ● ●	● ● ● ●	● ● ● ●



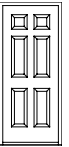

# Entry Doors



## Steel Panel Style, Size and Glazing Options

SP6-15

### Sidelights

Shape	Door Size	Reference Glass Size	Glass Type								Muntins	
			Juliet	Francesca	Victoria	Guinevere	Athena	Isabella	Clear	Low-E	Grilles-Between-Glass	The-Glass
	1'0 x 6'8	8 x 36	●	●	●	●	●	●	●	●	●	●
	1'2 x 6'8	8 x 36	●	●	●	●	●	●	●	●	●	●
	1'0 x 7'0	8 x 36	●	●	●	●	●	●	●	●	●	●
	1'2 x 7'0	8 x 36	●	●	●	●	●	●	●	●	●	●
	1'0 x 6'8	8 x 36			●	●				●		
	1'2 x 6'8	8 x 36			●	●				●		
	1'0 x 7'0	8 x 36			●	●				●		
	1'2 x 7'0	8 x 36			●	●				●		

### Direct Set Sidelight

	1'0 x 6'8								●	●	●
	1'2 x 6'8								●	●	●
	1'0 x 7'0								●	●	●
	1'2 x 7'0								●	●	●
	1'0 x 8'0								●	●	●
	1'2 x 8'0								●	●	●

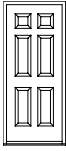







# Entry Doors

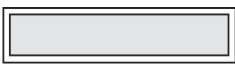

## Transoms - Shape, Size and Glazing Options

SP6-16

Shape	Frame Size (Width)	Glass Type								Muntins		
		Juliet	Francesca	Victoria	Guinevere	Athena	Isabella	Clear	Low-E	Grilles-Between-Glass	The-Glass	
Clad Rectangular 	33-1/2	●	●	●	●	●	●	●	●	●	●	●
	37-1/2	●	●	●	●	●	●	●	●	●	●	●
	60-1/2	●	●	●	●	●	●	●	●	●	●	●
	64-1/2	●	●	●	●	●	●	●	●	●	●	●
	68-1/2	●	●	●	●	●	●	●	●	●	●	●
Clad Half Circle 	33-1/2	●	●	●	●			●	●			
	37-1/2	●	●	●	●			●	●			
	60-1/2	●	●	●	●			●	●			
	64-1/2	●	●	●	●			●	●			
	68-1/2	●	●	●	●			●	●			
Clad Elliptical 	60-1/2		●	●	●			●	●			
	64-1/2		●	●	●			●	●			
	68-1/2		●	●	●			●	●			
Clad Arch Head 	33-1/2	●	●	●	●	●	●	●	●			
	37-1/2	●	●	●	●	●	●	●	●			
	60-1/2	●	●	●	●	●	●	●	●			
	64-1/2	●	●	●	●	●	●	●	●			
	68-1/2	●	●	●	●	●	●	●	●			
Wood Rectangular 	33-1/2							●	●			
	37-1/2							●	●			
	60-1/2							●	●			
	64-1/2							●	●			
	68-1/2							●	●			
Wood Half Circle 	33-1/2							●	●			
	37-1/2							●	●			
	60-1/2							●	●			
	64-1/2							●	●			
	68-1/2							●	●			



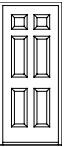

# Entry Doors



## Transoms - Shape, Size and Glazing Options

SP6-17

Shape	Frame Size (Width)	Glass Type								Muntins	
		Juliet	Francesca	Victoria	Guinevere	Athena	Isabella	Clear	Low-E	Grilles-Between-The-Glass	
Wood Elliptical 	60-1/2 64-1/2 68-1/2							●	●		
Wood Arch Head 	33-1/2 37-1/2 60-1/2 64-1/2 68-1/2							●	●		

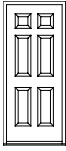

# Entry Doors



## Size Charts - Wood and Clad Doors

Product Code:  
 SPCIE (Clad)  
 SPWIE (Wood)

Scale 1/8" = 1' 0"

SP6-20

### In-Swing Single Doors & Sidelights

Masonry	3' 0 1/2" (927)	3' 4 1/2" (1 029)	1' 4 1/2" (419)	1' 6 1/2" (470)
Opening	2' 10 1/4" (870)	3' 2 1/4" (972)	1' 2 1/4" (362)	1' 4 1/4" (413)
Frame	2' 9 1/2" (851)	3' 1 1/2" (953)	1' 1 1/2" (343)	1' 3 1/2" (394)
6' 11" (2108)				
6' 10" (2083)				
6' 9 1/2" (2070)				
7' 3" (2210)				
7' 2" (2184)				
7' 1 1/2" (2172)				
8' 3" (2515)				
8' 2" (2489)				
8' 1 1/2" (2477)				

NOTES:

- Masonry dimensions include the use of Pella® Aluminum Traditional Trim (#72D6) for clad doors and brickmould for wood doors.
- All vent units are available with left or right-hand hinging. Exterior view of right-hand hinging shown.



# Entry Doors





Product Code: Size Charts - Wood  
 SPCOE (Clad)  
 SPWOE (Wood)

Scale 1/8" = 1' 0"

SP6-21

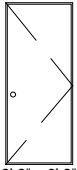
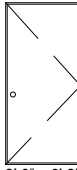
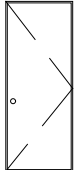
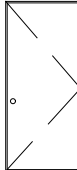
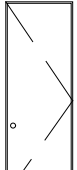
### Out-Swing Single Doors

	Masonry	3' 0 1/2" (927)	3' 4 1/2" (1 029)	
	Opening	2' 10 1/4" (670)	3' 2 1/4" (972)	
	Frame	2' 9 1/2" (851)	3' 1 1/2" (953)	
6' 10 1/2" (2 086)	6' 9 1/2" (2 070)	6' 9" (2 057)	 2' 8" x 6' 8"	 3' 0" x 6' 8"
7' 2 1/2" (2 197)	7' 1 1/2" (2 172)	7' 1" (2 159)	 2' 8" x 7' 0"	 3' 0" x 7' 0"
8' 2 1/2" (2 502)	8' 1 1/2" (2 477)	8' 1" (2 464)	 2' 8" x 8' 0"	 3' 0" x 8' 0"

NOTES:

- Masonry dimensions include the use of Pella® Aluminum Traditional Trim (#72D6) for clad doors and brickmould for wood doors.
- All vent units are available with left or right-hand hinging. Exterior view of right-hand hinging shown.

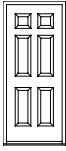

# Entry Doors



## Size Charts - Doors with Low Profile Sill

Product Code:  
 SPCIE (Clad In-Swing)  
 SPWIE (Wood In-Swing)

SP6-22

Scale 1/8" = 1' 0"

### In-Swing Single Doors

	Masonry	Opening	Frame
6' 10 <sup>1</sup> / <sub>4</sub> " (2 089)	3' 4 <sup>1</sup> / <sub>2</sub> " (1 029)	3' 2 <sup>1</sup> / <sub>4</sub> " (972)	3' 1 <sup>1</sup> / <sub>2</sub> " (953)
6' 9 <sup>1</sup> / <sub>4</sub> " (2 064)			
6' 8 <sup>3</sup> / <sub>4</sub> " (2 051)			
			3' 0" x 6' 8"
7' 2 <sup>1</sup> / <sub>4</sub> " (2 191)			
7' 1 <sup>1</sup> / <sub>4</sub> " (2 165)			
7' 0 <sup>3</sup> / <sub>4</sub> " (2 153)			
			3' 0" x 7' 0"
8' 2 <sup>1</sup> / <sub>4</sub> " (2 486)			
8' 1 <sup>1</sup> / <sub>4</sub> " (2 470)			
8' 0 <sup>3</sup> / <sub>4</sub> " (2 458)			
			3' 0" x 8' 0"

NOTES:

- Masonry dimensions include the use of Pella® Aluminum Traditional Trim (#72D6) for clad doors and brickmould for wood doors.
- All vent units are available with left or right-hand hinging. Exterior view of right-hand hinging shown.



# Entry Doors



Product Code:  
 SPWIE (20 Minute Fire Door)  
 SPSIE (90 Minute Fire Door)

## Size Charts - Fire Doors

Scale 1/8" = 1' 0"

SP6-23

### 20 Minute Fire Door\*

Opening	2' 10 <sup>1</sup> / <sub>4</sub> " (870)	3' 2 <sup>1</sup> / <sub>4</sub> " (972)
Frame	2' 9 <sup>1</sup> / <sub>2</sub> " (851)	3' 1 <sup>1</sup> / <sub>2</sub> " (953)

6' 10" (2083)	6' 9 <sup>1</sup> / <sub>2</sub> " (2070)		
		2' 8" x 6' 8"	3' 0" x 6' 8"

### 90 Minute Fire Door

Opening	2' 10 <sup>1</sup> / <sub>4</sub> " (870)	3' 2 <sup>1</sup> / <sub>4</sub> " (972)
Frame	2' 9 <sup>1</sup> / <sub>2</sub> " (851)	3' 1 <sup>1</sup> / <sub>2</sub> " (953)

  

6' 9 <sup>1</sup> / <sub>4</sub> " (2064)	6' 8 <sup>3</sup> / <sub>4</sub> " (2051)		
		2' 8" x 6' 8"	3' 0" x 6' 8"

\* Available in 4-9/16", 4-11/16", 6-9/16", and 6-11/16 wall depths only.

NOTES:

- All units are available with either Flush or 6-Panel door style and are In-Swing only.
- All vent units are available with left or right-hand hinging. Exterior view of right-hand hinging shown.

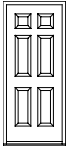

# Entry Doors



## Size Charts - Transoms

SP6-24

**Product Code:**  
 SPCTR (Clad Transom)  
 SPWTR (Wood Transom)  
 SPCCH (Clad Circlehead)  
 SPWCH (Wood Circlehead)

Scale 1/8" = 1' 0"

### RECTANGULAR AND ELLIPTICAL TRANSOMS

Masonry	3' 0 1/2" (927)	3' 4 1/2" (1 029)	5' 3 1/2" (1 613)	5' 7 1/2" (1 715)	5' 11 1/2" (1 816)
Opening	2' 10 1/4" (870)	3' 2 1/4" (972)	5' 1 1/4" (1 556)	5' 5 1/4" (1 657)	5' 9 1/4" (1 759)
Frame	2' 9 1/2" (851)	3' 1 1/2" (953)	5' 0 1/2" (1 537)	5' 4 1/2" (1 638)	5' 8 1/2" (1 740)

1' 2 3/4" (375)					
1' 4 3/4" (425)					
1' 4" (406)					
1' 4" (406)					
			R1 = 12" R2 = 55 5/8"	R1 = 12" R2 = 65 1/4"	R1 = 12" R2 = 75 7/8"

### ARCHHEAD TRANSOMS\*

Masonry	3' 0 1/2" (927)
Opening	2' 10 1/4" (870)
Frame	2' 9 1/2" (851)

1' 4 7/8" (429)	
1' 4 1/8" (410)	R = 36"

Masonry	3' 4 1/2" (1 029)
Opening	3' 2 1/4" (972)
Frame	3' 1 1/2" (953)

1' 5 1/4" (438)	
1' 4 1/2" (419)	R = 42"

Masonry	5' 3 1/2" (1 613)
Opening	5' 1 1/4" (1 556)
Frame	5' 0 1/2" (1 537)

1' 9" (533)	
1' 8 1/4" (514)	R = 60"

Masonry	5' 7 1/2" (1 715)
Opening	5' 5 1/4" (1 657)
Frame	5' 4 1/2" (1 638)

1' 8 3/8" (518)	
1' 7 5/8" (498)	R = 72"

Masonry	5' 11 1/2" (1 816)
Opening	5' 9 1/4" (1 759)
Frame	5' 8 1/2" (1 740)

1' 9 1/2" (546)	
1' 8 3/4" (527)	R = 72"

\* All straight legs = 1' 0" ((305)

### NOTES:

- Masonry dimensions include the use of Pella® Aluminum Traditional Trim (#72D6) for clad products and brickmould for wood products.



# Entry Doors



Product Code:  
 SPCCH (Clad Circlehead)  
 SPWCH (Wood Circlehead)

## Size Charts - Transoms

Scale 1/8" = 1' 0"

SP6-25

### HALF CIRCLE TRANSOMS

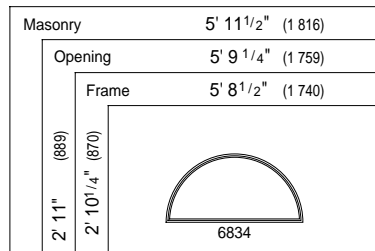
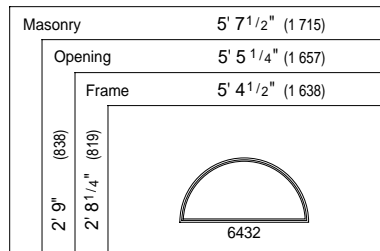
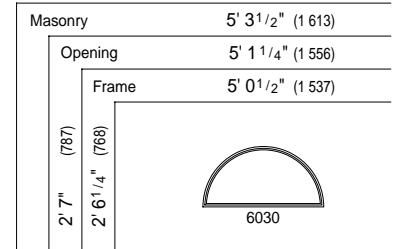
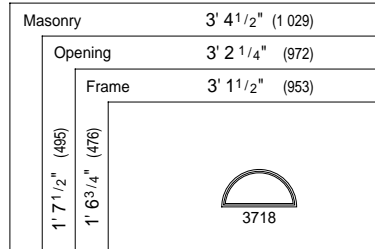
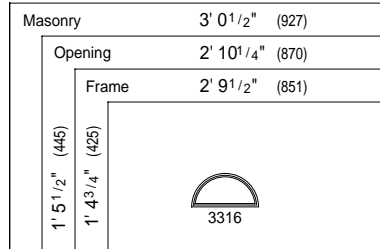

#### NOTES:

- Masonry dimensions include the use of Pella® Aluminum Traditional Trim (#72D6) for clad products and brickmould for wood products.

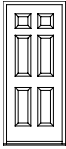

# Entry Doors



## Door/Sidelight Composites

Scale 1/8" = 1' 0"

SP6-26

### 2' 8" In-Swing Single Doors & Sidelights

Masonry	3' 0 <sup>1</sup> / <sub>2</sub> " (927)	4' 2" (1270)	5' 3 <sup>1</sup> / <sub>2</sub> " (1613)	4' 4" (1321)	5' 7 <sup>1</sup> / <sub>2</sub> " (1715)
Opening	2' 10 <sup>1</sup> / <sub>4</sub> " (870)	3' 11 <sup>3</sup> / <sub>4</sub> " (1213)	5' 1 <sup>1</sup> / <sub>4</sub> " (1556)	4' 1 <sup>3</sup> / <sub>4</sub> " (1264)	5' 5 <sup>1</sup> / <sub>4</sub> " (1657)
Frame	2' 9 <sup>1</sup> / <sub>2</sub> " (851)	3' 11" (1194)	5' 0 <sup>1</sup> / <sub>2</sub> " (1537)	4' 1" (1245)	5' 4 <sup>1</sup> / <sub>2</sub> " (1638)
6' 11" (2108)					
6' 10" (2083)		1' 0" SIDELIGHT	(2) 1' 0" SIDELIGHTS	1' 2" SIDELIGHT	(2) 1' 2" SIDELIGHTS
6' 9 <sup>1</sup> / <sub>2</sub> " (2070)					
7' 3" (2210)					
7' 2" (2184)		1' 0" SIDELIGHT	(2) 1' 0" SIDELIGHTS	1' 2" SIDELIGHT	(2) 1' 2" SIDELIGHTS
7' 1 <sup>1</sup> / <sub>2</sub> " (2172)					
8' 3" (2515)					
8' 2" (2489)		1' 0" SIDELIGHT	(2) 1' 0" SIDELIGHTS	1' 2" SIDELIGHT	(2) 1' 2" SIDELIGHTS
8' 1 <sup>1</sup> / <sub>2</sub> " (2477)					

NOTES:

- Masonry dimensions include the use of Pella® Aluminum Traditional Trim (#72D6) for clad products and brickmould for wood products.



# Entry Doors



Scale 1/8" = 1' 0"

## Door/Sidelight Composites

SP6-27

### 3' 0" In-Swing Single Doors & Sidelights

Masonry	3' 4 1/2" (1 029)	4' 6" (1 372)	5' 7 1/2" (1 715)	4' 8" (1 422)	5' 11 1/2" (1 816)
Opening	3' 2 1/4" (972)	4' 3 3/4" (1 314)	5' 5 1/4" (1 657)	4' 5 3/4" (1 365)	5' 9 1/4" (1 759)
Frame	3' 1 1/2" (953)	4' 3" (1 295)	5' 4 1/2" (1 638)	4' 5" (1 346)	5' 8 1/2" (1 740)
6' 11" (2 108)					
6' 10" (2 083)					
6' 9 1/2" (2 070)					
7' 3" (2 210)					
7' 2" (2 184)					
7' 1 1/2" (2 172)					
8' 3" (2 515)					
8' 2" (2 489)					
8' 1 1/2" (2 477)					

NOTES:

- Masonry dimensions include the use of Pella® Aluminum Traditional Trim (#72D6) for clad products and brickmould for wood products.

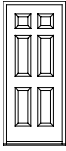

# Entry Doors



## Door/Transom Composites

Scale 1/8" = 1' 0"

SP6-28

### 2' 8" x 6' 8" In-Swing Doors with Rectangular and Elliptical Transoms

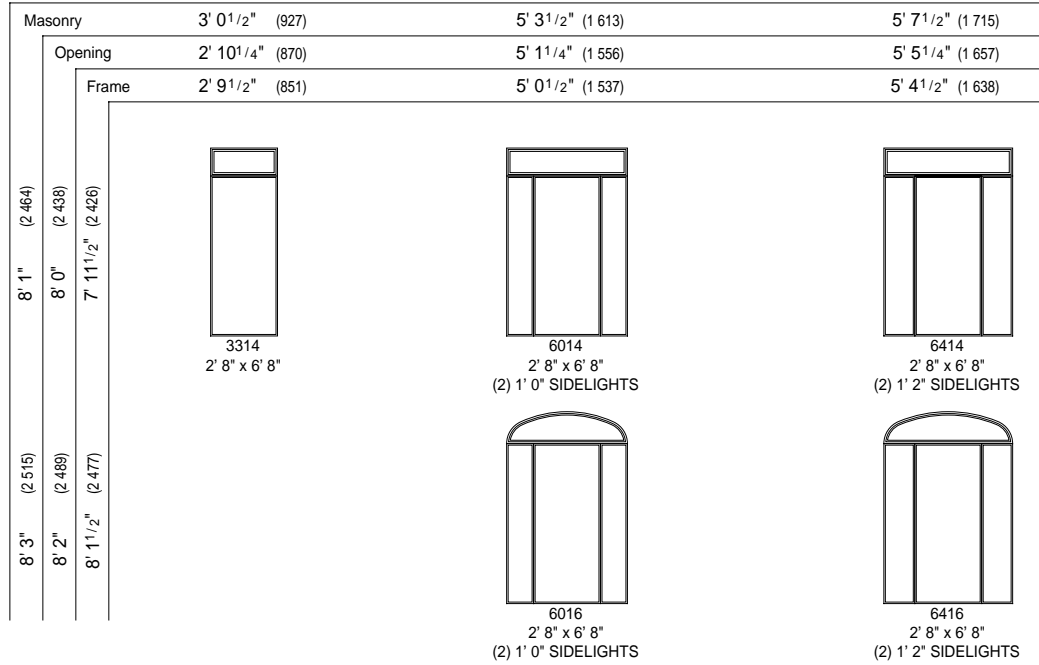

### 2' 8" x 6' 8" In-Swing Doors with Circlehead and Arch Head Transoms

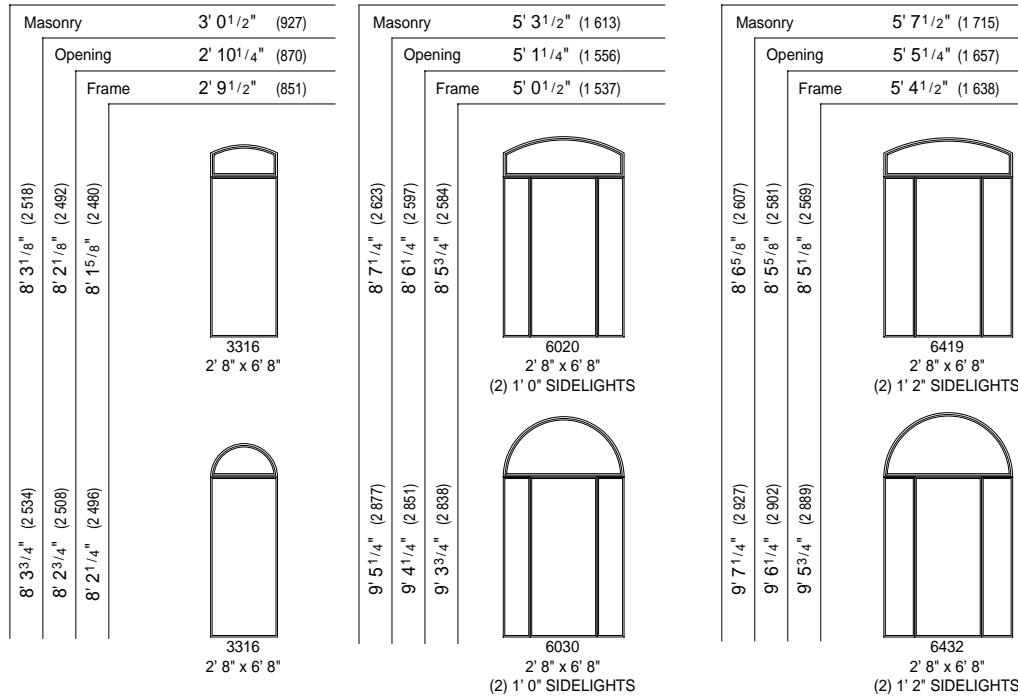

NOTES:

- Masonry dimensions include the use of Pella® Aluminum Traditional Trim (#72D6) for clad products and brickmould for wood products.



# Entry Doors

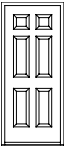

Scale 1/8" = 1' 0"

## Door/Transom Composites

SP6-29

### 2' 8" x 7'0" In-Swing Doors with Rectangular and Elliptical Transoms

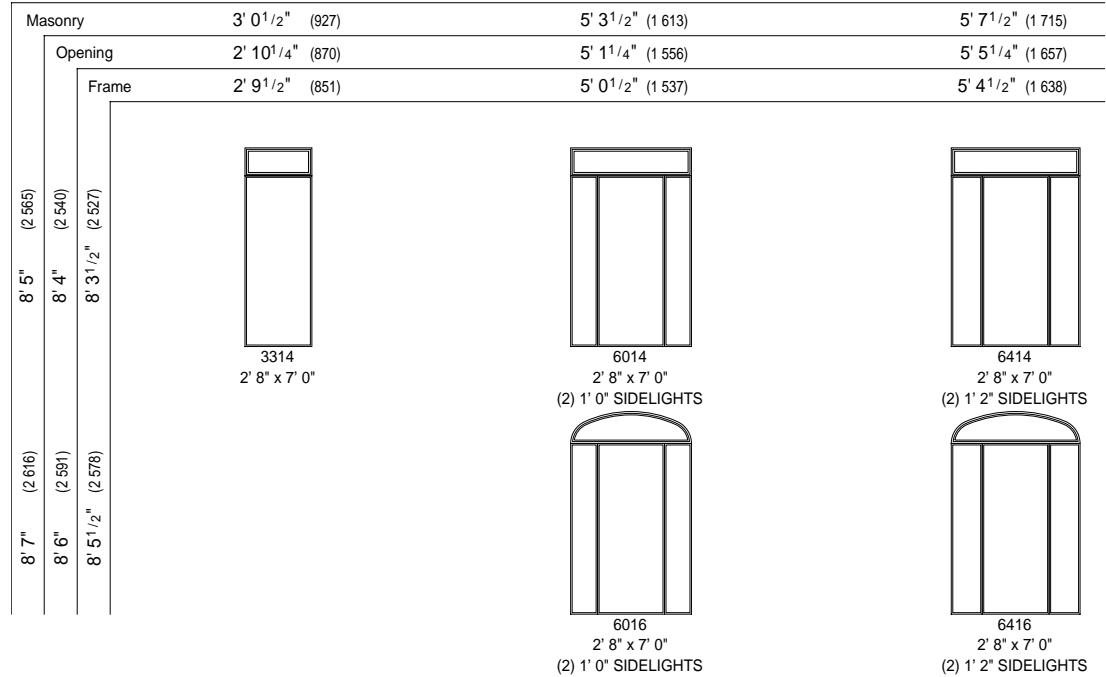

### 2' 8" x 7' 0" In-Swing Doors with Circlehead and Arch Head Transoms

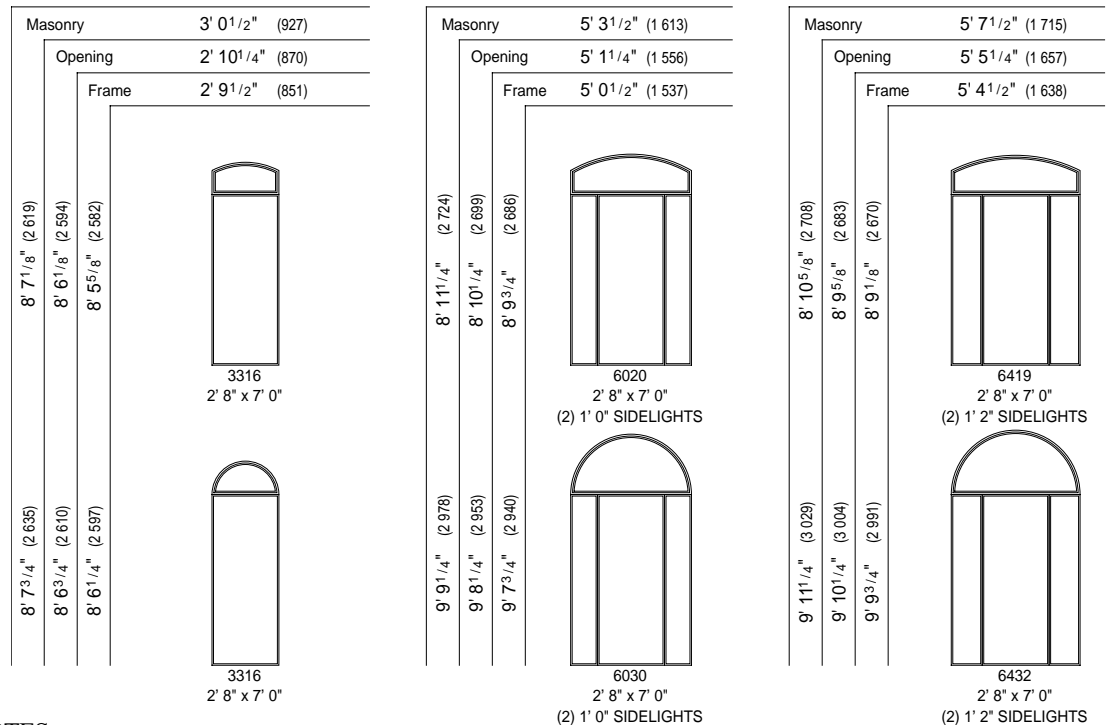

NOTES:

- Masonry dimensions include the use of Pella® Aluminum Traditional Trim (#72D6) for clad products and brickmould for wood products.

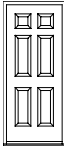

# Entry Doors



## Door/Transom Composites

Scale 1/8" = 1' 0"

SP6-30

### 2' 8" x 8' 0" In-Swing Doors with Rectangular and Elliptical Transoms

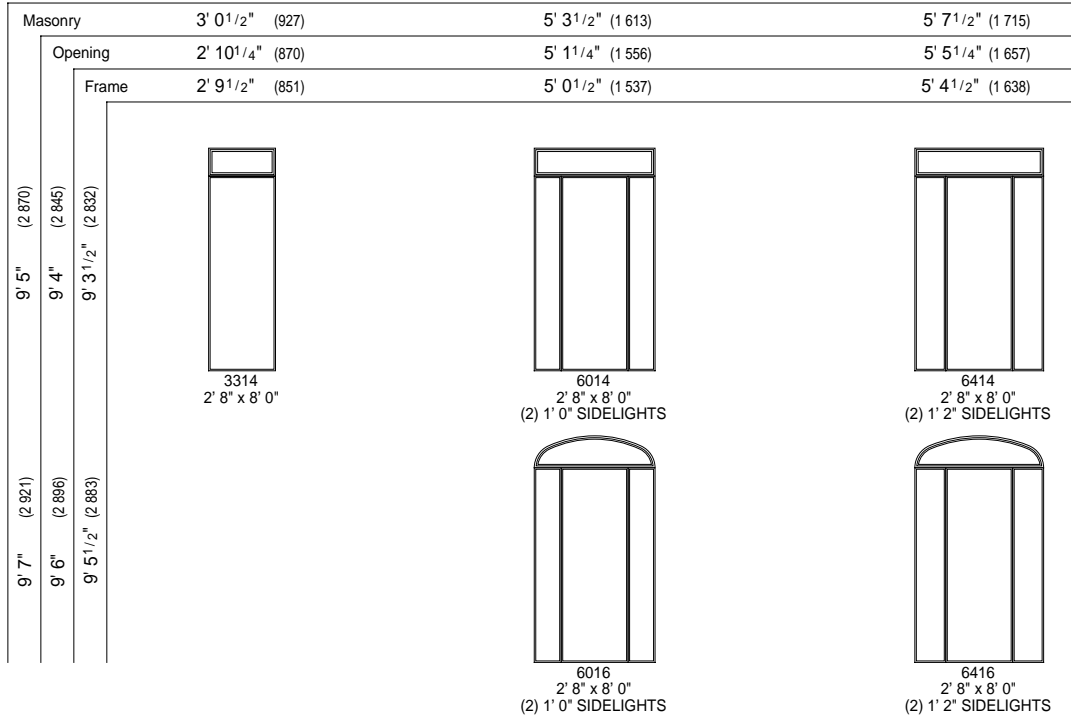

### 2' 8" x 8' 0" In-Swing Doors with Circlehead and Arch Head Transoms

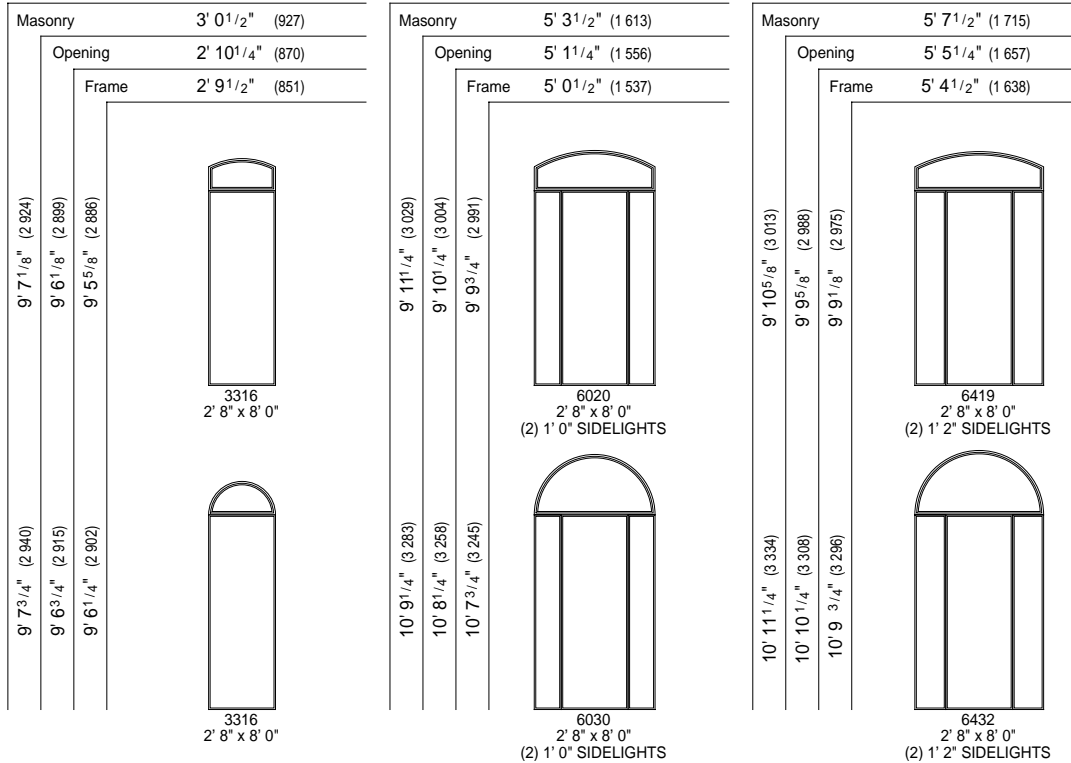

NOTES:  
 • Masonry dimensions include the use of Pella® Aluminum Traditional Trim (#72D6) for clad products and brickmould for wood products.



# Entry Doors

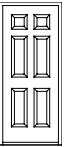

Scale 1/8" = 1' 0"

## Door/Transom Composites

SP6-31

### 3' 0" x 6' 8" In-Swing Doors with Rectangular and Elliptical Transoms

Masonry	3' 4 1/2" (1 029)	5' 7 1/2" (1 715)	5' 11 1/2" (1 816)
Opening	3' 2 1/4" (972)	5' 5 1/4" (1 657)	5' 9 1/4" (1 759)
Frame	3' 1 1/2" (953)	5' 4 1/2" (1 638)	5' 8 1/2" (1 740)

8' 3" (2 515)	8' 1" (2 464)	
8' 2" (2 489)	8' 0" (2 438)	
8' 1 1/2" (2 477)	7' 11 1/2" (2 426)	



3714  
3' 0" x 6' 8"

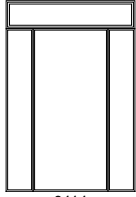

6414  
3' 0" x 6' 8"  
(2) 1' 0" SIDELIGHTS

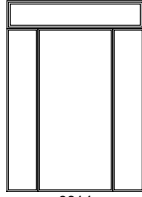

6814  
3' 0" x 6' 8"  
(2) 1' 2" SIDELIGHTS

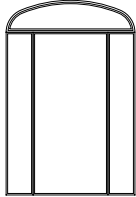

6416  
3' 0" x 6' 8"  
(2) 1' 0" SIDELIGHTS

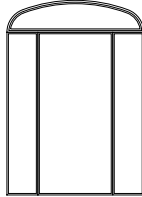

6816  
3' 0" x 6' 8"  
(2) 1' 2" SIDELIGHTS

### 3' 0" x 6' 8" In-Swing Doors with Circlehead and Arch Head Transoms

Masonry	3' 4 1/2" (1 029)	5' 7 1/2" (1 715)	5' 11 1/2" (1 816)
Opening	3' 2 1/4" (972)	5' 5 1/4" (1 657)	5' 9 1/4" (1 759)
Frame	3' 1 1/2" (953)	5' 4 1/2" (1 638)	5' 8 1/2" (1 740)

8' 5 3/4" (2 584)	8' 3 1/2" (2 527)	
8' 4 3/4" (2 559)	8' 2 1/2" (2 502)	
8' 4 1/4" (2 546)	8' 2" (2 489)	



3716  
3' 0" x 6' 8"

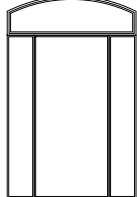

6419  
3' 0" x 6' 8"  
(2) 1' 0" SIDELIGHTS

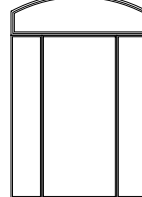

6820  
3' 0" x 6' 8"  
(2) 1' 2" SIDELIGHTS

9' 7 1/4" (2 927)	8' 6 5/8" (2 607)	
9' 6 1/4" (2 902)	8' 5 5/8" (2 581)	
9' 5 3/4" (2 889)	8' 5 1/8" (2 569)	

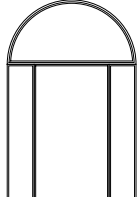

6432  
3' 0" x 6' 8"  
(2) 1' 0" SIDELIGHTS

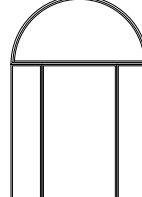

6834  
3' 0" x 6' 8"  
(2) 1' 2" SIDELIGHTS

NOTES:  
 • Masonry dimensions include the use of Pella® Aluminum Traditional Trim (#72D6) for clad products and brickmould for wood products.

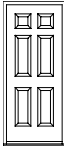

# Entry Doors



## Door/Transom Composites

Scale 1/8" = 1' 0"

SP6-32



### 3' 0" x 7' 0" In-Swing Doors with Rectangular and Elliptical Transoms

Masonry	3' 4 1/2" (1 029)	5' 7 1/2" (1 715)	5' 11 1/2" (1 816)
Opening	3' 2 1/4" (972)	5' 5 1/4" (1 657)	5' 9 1/4" (1 759)
Frame	3' 1 1/2" (953)	5' 4 1/2" (1 638)	5' 8 1/2" (1 740)

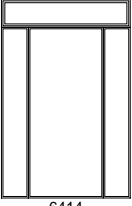
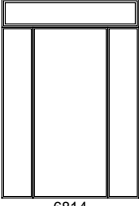
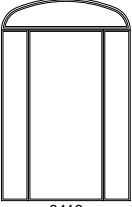
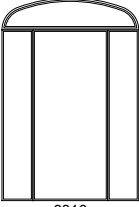
8' 5" (2 565)			
	3714 3' 0" x 7' 0"	6414 3' 0" x 7' 0" (2) 1' 0" SIDELIGHTS	6814 3' 0" x 7' 0" (2) 1' 2" SIDELIGHTS
8' 7" (2 616)			
	6416 3' 0" x 7' 0" (2) 1' 0" SIDELIGHTS	6816 3' 0" x 7' 0" (2) 1' 2" SIDELIGHTS	

### 3' 0" x 7' 0" In-Swing Doors with Circlehead & Arch Head Transoms

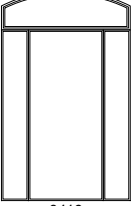
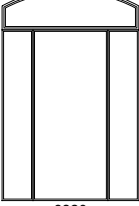
8' 7 1/2" (2 629)			
	3716 3' 0" x 7' 0"	6419 3' 0" x 7' 0" (2) 1' 0" SIDELIGHTS	6820 3' 0" x 7' 0" (2) 1' 2" SIDELIGHTS
8' 9 3/4" (2 686)			
	3718 3' 0" x 7' 0"	6432 3' 0" x 7' 0" (2) 1' 0" SIDELIGHTS	6834 3' 0" x 7' 0" (2) 1' 2" SIDELIGHTS

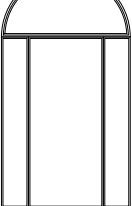
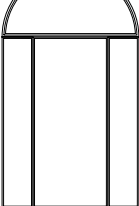
Masonry	3' 4 1/2" (1 029)	5' 7 1/2" (1 715)	5' 11 1/2" (1 816)
Opening	3' 2 1/4" (972)	5' 5 1/4" (1 657)	5' 9 1/4" (1 759)
Frame	3' 1 1/2" (953)	5' 4 1/2" (1 638)	5' 8 1/2" (1 740)

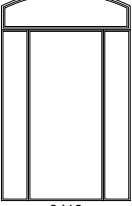
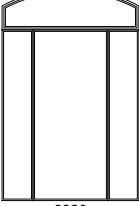
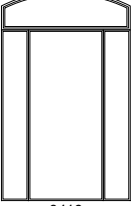
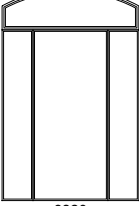

8' 6 1/2" (2 604)			
	3716 3' 0" x 7' 0"	6419 3' 0" x 7' 0" (2) 1' 0" SIDELIGHTS	6820 3' 0" x 7' 0" (2) 1' 2" SIDELIGHTS
8' 10 5/8" (2 708)			
	6419 3' 0" x 7' 0" (2) 1' 0" SIDELIGHTS	6820 3' 0" x 7' 0" (2) 1' 2" SIDELIGHTS	

NOTES:  
 • Masonry dimensions include the use of Pella® Aluminum Traditional Trim (#72D6) for clad products and brickmould for wood products.



# Entry Doors

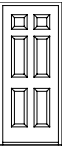

Scale 1/8" = 1' 0"

## Door/Transom Composites

SP6-33

NOTES:  
 • Masonry dimensions include the use of Pella® Aluminum Traditional Trim (#72D6) for clad products and brickmould for wood products.

### 3' 0" x 8' 0" In-Swing Doors with Rectangular and Elliptical Transoms

Masonry	3' 4 1/2" (1 029)	5' 7 1/2" (1 715)	5' 11 1/2" (1 816)
Opening	3' 2 1/4" (972)	5' 5 1/4" (1 657)	5' 9 1/4" (1 759)
Frame	3' 1 1/2" (953)	5' 4 1/2" (1 638)	5' 8 1/2" (1 740)

9' 5" (2 870)			
9' 4" (2 845)	3714 3' 0" x 8' 0"	6414 3' 0" x 8' 0" (2) 1' 0" SIDELIGHTS	6814 3' 0" x 8' 0" (2) 1' 2" SIDELIGHTS
9' 7" (2 921)			
9' 6" (2 896)	3716 3' 0" x 8' 0"	6416 3' 0" x 8' 0" (2) 1' 0" SIDELIGHTS	6816 3' 0" x 8' 0" (2) 1' 2" SIDELIGHTS
9' 5 1/2" (2 883)			

### 3' 0" x 8' 0" In-Swing Doors with Circlehead & Arch Head Transoms

9' 7 1/2" (2 934)			
9' 6 1/2" (2 908)	3716 3' 0" x 8' 0"	6419 3' 0" x 8' 0" (2) 1' 0" SIDELIGHTS	6820 3' 0" x 8' 0" (2) 1' 2" SIDELIGHTS
9' 6" (2 896)			
9' 9 3/4" (2 991)			
9' 8 3/4" (2 965)	3718 3' 0" x 8' 0"	6432 3' 0" x 8' 0" (2) 1' 0" SIDELIGHTS	6834 3' 0" x 8' 0" (2) 1' 2" SIDELIGHTS
9' 8 1/4" (2 963)			

Masonry	3' 4 1/2" (1 029)	5' 7 1/2" (1 715)	5' 11 1/2" (1 816)
Opening	3' 2 1/4" (972)	5' 5 1/4" (1 657)	5' 9 1/4" (1 759)
Frame	3' 1 1/2" (953)	5' 4 1/2" (1 638)	5' 8 1/2" (1 740)

9' 10 5/8" (3 013)		
9' 9 5/8" (2 988)	6419 3' 0" x 8' 0" (2) 1' 0" SIDELIGHTS	6820 3' 0" x 8' 0" (2) 1' 2" SIDELIGHTS
9' 9 1/8" (2 975)		
10' 11 1/4" (3 334)		
10' 10 1/4" (3 321)	6432 3' 0" x 8' 0" (2) 1' 0" SIDELIGHTS	6834 3' 0" x 8' 0" (2) 1' 2" SIDELIGHTS
10' 9 3/4" (3 296)		

9' 11 3/4" (3 042)		
9' 10 3/4" (3 016)	6820 3' 0" x 8' 0" (2) 1' 2" SIDELIGHTS	6834 3' 0" x 8' 0" (2) 1' 2" SIDELIGHTS
9' 10 1/4" (3 004)		
11' 11 1/4" (3 385)		
11' 10 1/4" (3 359)	6834 3' 0" x 8' 0" (2) 1' 2" SIDELIGHTS	6834 3' 0" x 8' 0" (2) 1' 2" SIDELIGHTS
10' 11 3/4" (3 346)		



# Entry Doors

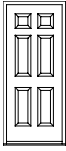

## Door/Transom Composites

Scale 1/8" = 1' 0"

SP6-34

2' 8" x 6' 8" Out-Swing Doors with Transoms

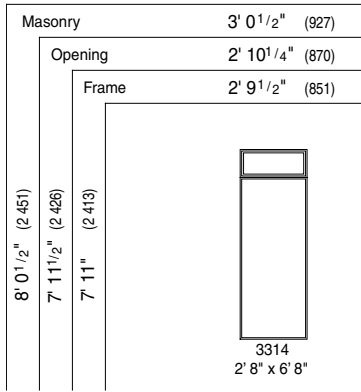

2' 8" x 7' 0" Out-Swing Doors with Transoms

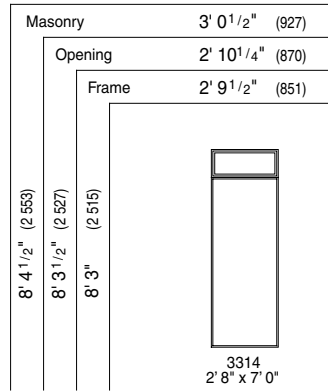

2' 8" x 8' 0" Out-Swing Doors with Transoms

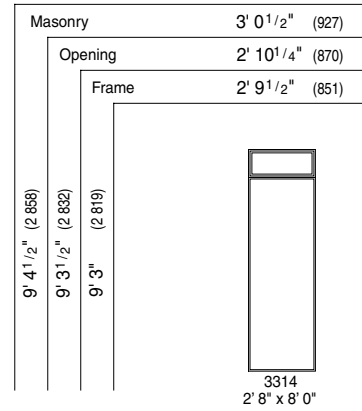

2' 8" x 6' 8" Out-Swing Doors with Circlehead & Arch Head Transoms

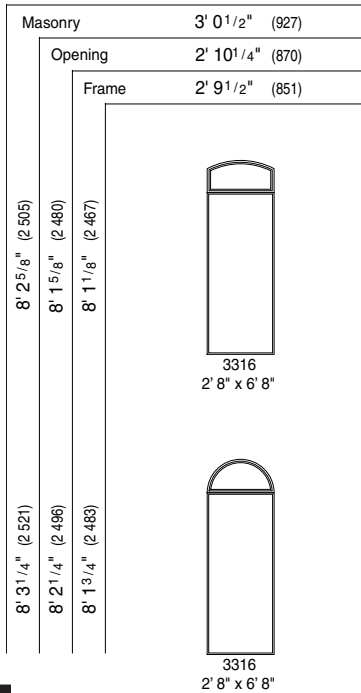

2' 8" x 7' 0" Out-Swing Doors with Circlehead & Arch Head Transoms

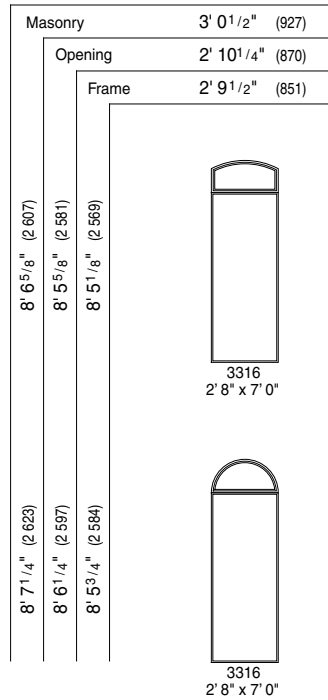

2' 8" x 8' 0" Out-Swing Doors with Circlehead & Arch Head Transoms

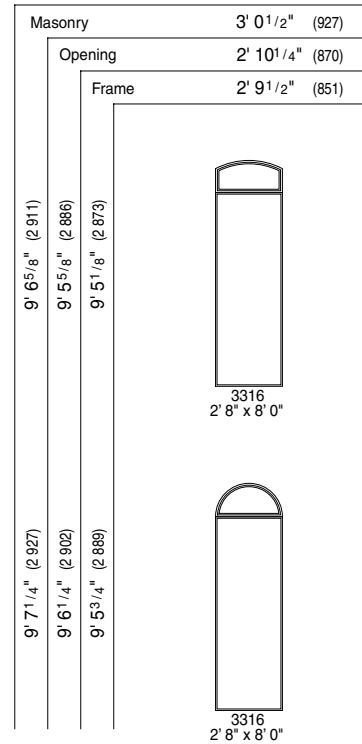

NOTES:  
 • Masonry dimensions include the use of Pella® brickmould for wood products.



# Entry Doors

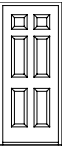

Scale 1/8" = 1' 0"

## Door/Transom Composites

SP6-35

NOTES:  
 • Masonry dimensions include the use of Pella® brickmould for wood products.

3' 0" x 6' 8" Out-Swing Doors with Transoms

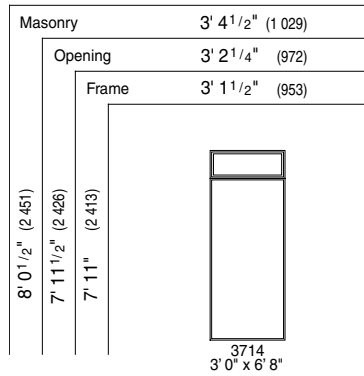

3' 0" x 7' 0" Out-Swing Doors with Transoms

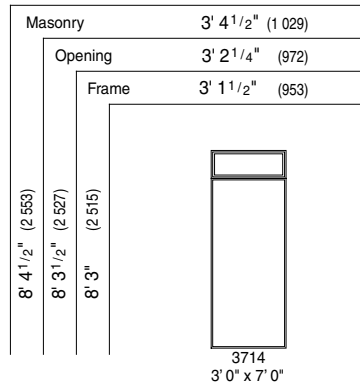

3' 0" x 8' 0" Out-Swing Doors with Transoms

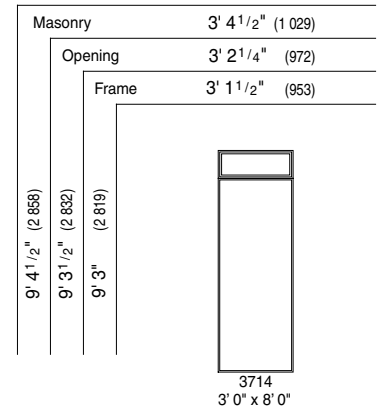

3' 0" x 6' 8" Out-Swing Doors with Circlehead & Arch Head Transoms

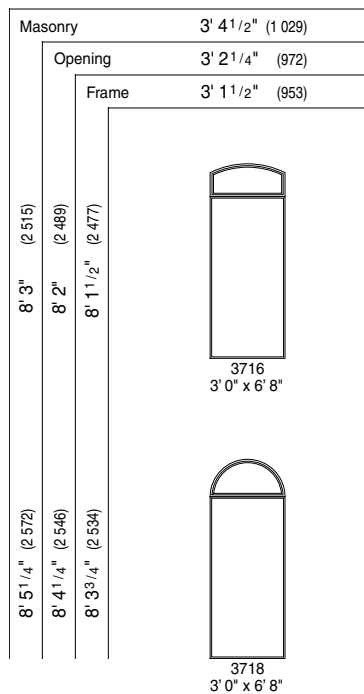

3' 0" x 7' 0" Out-Swing Doors with Circlehead & Arch Head Transoms

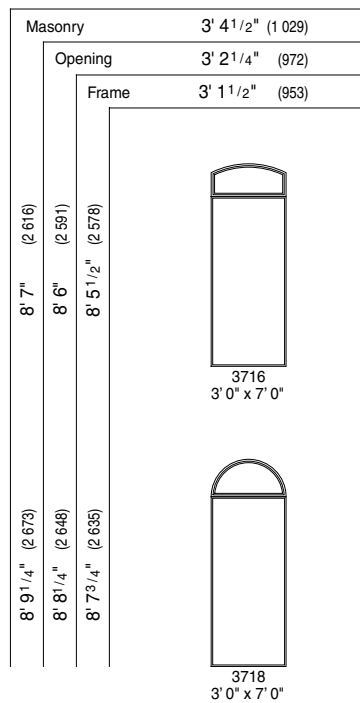

3' 0" x 8' 0" Out-Swing Doors with Circlehead & Arch Head Transoms

